

## Power Metal Film Leaded Resistors

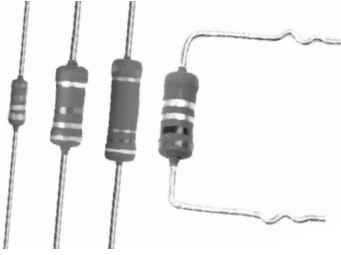

### DESCRIPTION

A homogeneous film of metal alloy is deposited on a high grade ceramic body. After a helical groove has been cut in the resistive layer, tinned connecting wires of electrolytic copper or copper-clad iron are welded to the end-caps. The resistors are coated with a red, non-flammable lacquer which provides electrical, mechanical and climatic protection. This coating is not resistant to aggressive fluxes and cleaning solvents. The encapsulation is resistant to all cleaning solvents in accordance with IEC 60068-2-45.

### FEATURES

- High power in small packages (1 W/0207 size to 3 W/0617 size)
- Different lead materials for different applications
- Defined interruption behaviour
- Technology: Metal film
- AEC-Q200 qualified (PR01 and PR02)
- Lead (Pb)-free solder contacts
- Pure tin plating provides compatibility with lead (Pb)-free and lead containing soldering processes
- Material categorization: For definitions of compliance please see [www.vishay.com/doc?99912](http://www.vishay.com/doc?99912)

**RoHS  
COMPLIANT**

### APPLICATIONS

- All general purpose power applications

TECHNICAL SPECIFICATIONS						
DESCRIPTION	UNIT	PR01	PR02 Cu-lead	PR02 FeCu-lead	PR03 Cu-lead	PR03 FeCu-lead
Resistance range <sup>(2)</sup>	Ω	0.22 to 1M	0.33 to 1M	1 to 1M	0.68 to 1M	1 to 1M
Resistance tolerance	%	± 1; ± 5	± 1; ± 5	± 1; ± 5	± 1; ± 5	± 1; ± 5
Resistance series		± 1 (E24, E96); ± 5 (E24 series) <sup>(1)</sup>				
Rated dissipation, $P_{70}$ $1 \Omega \leq R$	W	1	2	1.3	3	2.5
$R < 1 \Omega$		0.6	1.2	-	1.6	-
Thermal resistance ( $R_{th}$ )	K/W	135	75	115	60	75
Temperature coefficient	ppm/K	≤ ± 250	≤ ± 250	≤ ± 250	≤ ± 250	≤ ± 250
Maximum permissible voltage ( $U_{max}$ , AC/DC)	V	350	500	500	750	750
Basic specifications		IEC 60115-1				
Climatic category (IEC 60068-1)		55/155/56				
Stability after:						
Load (1000 h, $P_{70}$ )			$\Delta R$ max.: ± (5 % $R$ + 0.1 Ω)			
Long term damp heat test (56 days)			$\Delta R$ max.: ± (3 % $R$ + 0.1 Ω)			
Soldering (10 s, 260 °C)			$\Delta R$ max.: ± (1 % $R$ + 0.05 Ω)			

### Notes

- $R$  value is measured with probe distance of 24 mm ± 1 mm using 4-terminal method.
- <sup>(1)</sup> 1 % tolerance is available for  $R_n$ -range from 1  $R$  upwards.
- <sup>(2)</sup> Ohmic values (other than resistance range) are available on request.



PART NUMBER AND PRODUCT DESCRIPTION																								
Part Number: PR02000201001JA100																								
<table border="1" style="width:100%; text-align:center;"> <tr> <td>P</td><td>R</td><td>0</td><td>2</td><td>0</td><td>0</td><td>2</td><td>0</td><td>1</td><td>0</td><td>0</td><td>1</td><td>J</td><td>A</td><td>1</td><td>0</td><td>0</td> </tr> </table>								P	R	0	2	0	0	2	0	1	0	0	1	J	A	1	0	0
P	R	0	2	0	0	2	0	1	0	0	1	J	A	1	0	0								
MODEL/SIZE	VARIANT	WIRE TYPES	TCR/MATERIAL	VALUE	TOLERANCE	PACKAGING (1)	SPECIAL																	
PR0100 PR0200 PR0300	0 = Neutral Z = Value overflow (Special)	1 = Cu 0.6 2 = Cu 0.8 3 = FeCu 0.6 4 = FeCu 0.8	0 = Standard	3 digit value 1 digit multiplier MULTIPLIER 7 = *10 <sup>-3</sup> 2 = *10 <sup>2</sup> 8 = *10 <sup>-2</sup> 3 = *10 <sup>3</sup> 9 = *10 <sup>-1</sup> 4 = *10 <sup>4</sup> 0 = *10 <sup>0</sup> 5 = *10 <sup>5</sup> 1 = *10 <sup>1</sup>	F = ± 1 % J = ± 5 %	N4    R2 N3    L1 A5    DC A1    K1 AC    B1 R5    PC	The 2 digits are used for all special parts. 00 = Standard																	
Product Description: PR02 5 % A1 1K0																								
<table border="1" style="width:100%;"> <tr><td>PR02</td></tr> <tr><td>MODEL/SIZE</td></tr> <tr><td>PR01 PR02 PR03</td></tr> </table>		PR02	MODEL/SIZE	PR01 PR02 PR03	<table border="1" style="width:100%;"> <tr><td>5 %</td></tr> <tr><td>TOLERANCE</td></tr> <tr><td>± 1 % ± 5 %</td></tr> </table>		5 %	TOLERANCE	± 1 % ± 5 %	<table border="1" style="width:100%;"> <tr><td>A1</td></tr> <tr><td>PACKAGING (1)</td></tr> <tr><td>N4    L1 N3    DC A5    K1 A1    B1 AC    PC R5    R2</td></tr> </table>		A1	PACKAGING (1)	N4    L1 N3    DC A5    K1 A1    B1 AC    PC R5    R2	<table border="1" style="width:100%;"> <tr><td>1K0</td></tr> <tr><td>RESISTANCE VALUE</td></tr> <tr><td>1K0 = 1 kΩ 4K75 = 4.75 kΩ</td></tr> </table>		1K0	RESISTANCE VALUE	1K0 = 1 kΩ 4K75 = 4.75 kΩ					
PR02																								
MODEL/SIZE																								
PR01 PR02 PR03																								
5 %																								
TOLERANCE																								
± 1 % ± 5 %																								
A1																								
PACKAGING (1)																								
N4    L1 N3    DC A5    K1 A1    B1 AC    PC R5    R2																								
1K0																								
RESISTANCE VALUE																								
1K0 = 1 kΩ 4K75 = 4.75 kΩ																								

**Notes**

- The PART NUMBER is shown to facilitate the introduction of a unified part numbering system for ordering products.
- (1) Please refer to table PACKAGING for details.

PACKAGING								
MODEL	TAPING	AMMO PACK		REEL		BULK, DOUBLE KINK		
		PIECES	CODE	PIECES	CODE	PITCH	PIECES	CODE
PR01	Axial, 52 mm Wire Cu 0.6 mm and FeCu 0.6 mm	5000	A5	5000	R5			
		1000	A1					
	Radial Wire Cu 0.6 mm	4000	N4			17.8 mm Wire Cu 0.6 mm or FeCu 0.6 mm	1000	L1
						12.5 mm Wire FeCu 0.6 mm	1000	K1
PR02	Axial, 52 mm Wire Cu 0.8 mm and FeCu 0.6 mm	1000	A1	5000 only with Cu 0.8 mm	R5			
	Radial Wire Cu 0.8 mm and FeCu 0.6 mm	3000 only with Cu 0.8 mm	N3	2000 only with Cu 0.8 mm	R2	17.8 mm Wire Cu 0.8 mm and FeCu 0.6 mm	1000	L1
						15.0 mm only with FeCu 0.8 mm Wire FeCu 0.6 mm	1000	B1
PR03	Axial, 63 mm Wire Cu 0.8 mm and FeCu 0.6 mm	500	AC					
	Radial Wire Cu 0.8 mm and FeCu 0.6 mm					25.4 mm Wire Cu 0.8 mm and FeCu 0.6 mm	500	DC
						20 mm Wire FeCu 0.8 mm	500	PC

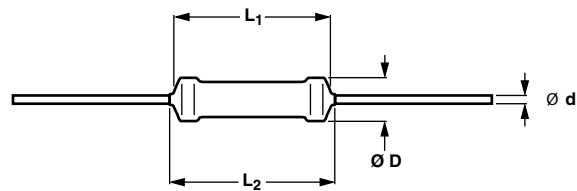
**DIMENSIONS**

Type with straight leads

<b>DIMENSIONS</b> - Straight lead type and relevant physical dimensions; see straight leads outline					
TYPE	Ø D <sub>MAX.</sub> (mm)	L <sub>1</sub> MAX. (mm)	L <sub>2</sub> MAX. (mm)	Ø d (mm)	
				Cu	FeCu
PR01	2.5	6.5	8.0	0.58 ± 0.05	-
PR02	3.9	10.0	12.0	0.78 ± 0.05	0.58 ± 0.05
PR03	5.2	16.7	19.5	0.78 ± 0.05	0.58 ± 0.05

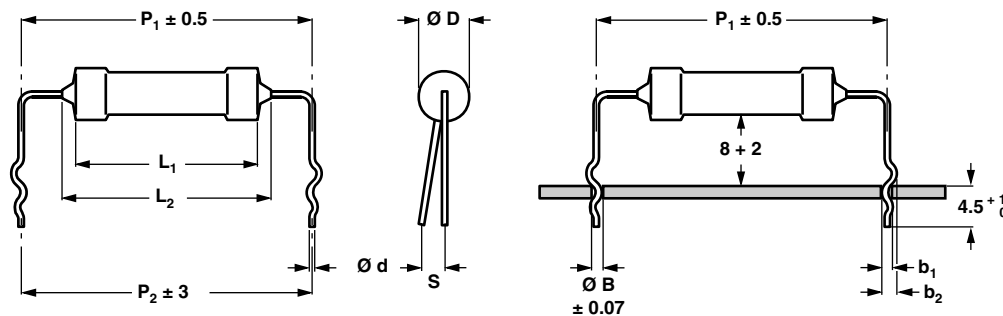
 Type with double kink Dimensions in millimeter

<b>DIMENSIONS</b> - Double kink lead type and relevant physical dimensions; see double kinked outline										
TYPE	LEAD STYLE	Ø d (mm)		b <sub>1</sub> (mm)	b <sub>2</sub> (mm)	Ø D <sub>MAX.</sub> (mm)	P <sub>1</sub> (mm)	P <sub>2</sub> (mm)	S <sub>MAX.</sub> (mm)	Ø B (mm)
		Cu	FeCu							
PR01	Double kink 17.8 mm pitch	0.58 ± 0.05	0.58 ± 0.05	1.10 + 0.25/- 0.20	1.45 + 0.25/- 0.20	2.5	17.8	17.8	2	0.8
	Double kink 12.5 mm pitch	-	0.58 ± 0.05	1.10 + 0.25/- 0.20	1.45 + 0.25/- 0.20		12.5	12.5	2	0.8
PR02	Double kink 17.8 mm pitch	0.78 ± 0.05	0.58 ± 0.05	1.10 + 0.25/- 0.20	1.45 + 0.25/- 0.20	3.9	17.8	17.8	2	0.8
	Double kink 12.5 mm pitch	-	0.78 ± 0.05	1.30 + 0.25/- 0.20	1.65 + 0.25/- 0.20		15.0	15.0	2	1.0
PR03	Double kink 17.8 mm pitch	0.78 ± 0.05	0.58 ± 0.05	1.10 + 0.25/- 0.20	1.65 + 0.25/- 0.20	5.2	25.4	25.4	2	1.0
	Double kink 12.5 mm pitch	-	0.78 ± 0.05	1.30 + 0.25/- 0.20	2.15 + 0.25/- 0.20		22.0	20.0	2	1.0

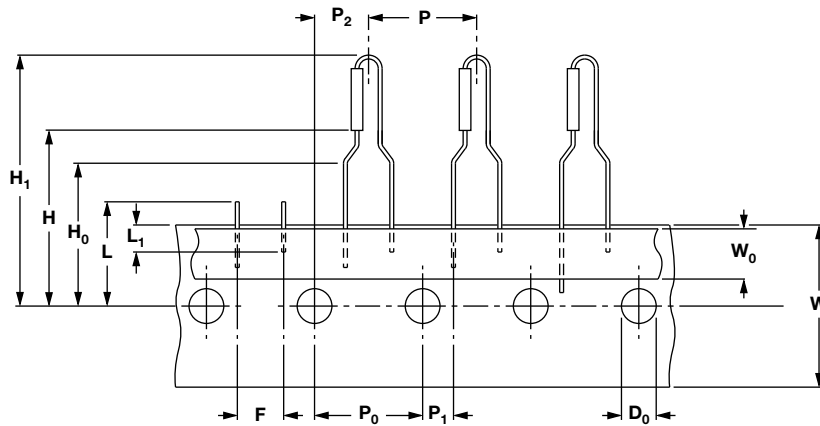
**PRODUCTS WITH RADIAL LEADS (PR01, PR02)**

DIMENSIONS - Radial taping				
SYMBOL	PARAMETER	VALUE	TOLERANCE	UNIT
P	Pitch of components	12.7	± 1.0	mm
P <sub>0</sub>	Feed-hole pitch	12.7	± 0.2	mm
P <sub>1</sub>	Feed-hole centre to lead at topside at the tape	3.85	± 0.5	mm
P <sub>2</sub>	Feed-hole center to body center	6.35	± 1.0	mm
F	Lead-to-lead distance	4.8	+ 0.7/- 0	mm
W	Tape width	18.0	± 0.5	mm
W <sub>0</sub>	Minimum hold down tape width	5.5	-	mm
H <sub>1</sub>	Component height PR01	29	Max.	mm
	Component height PR02	29	± 3.0	
H <sub>0</sub>	Lead wire clinch height	16.5	± 0.5	mm
H	Height of component from tape center	19.5	± 1	mm
D <sub>0</sub>	Feed-hole diameter	4.0	± 0.2	mm
L	Maximum length of snapped lead	11.0	-	mm
L <sub>1</sub>	Minimum lead wire (tape portion) shortest lead	2.5	-	mm

**Note**

- Please refer Packaging document ([www.vishay.com/doc?28721](http://www.vishay.com/doc?28721)) for more detail.

MASS PER UNIT	
TYPE	MASS (mg)
PR01 Cu 0.6 mm	212
PR01 FeCu 0.6 mm	207
PR02 Cu 0.8 mm	504
PR02 FeCu 0.6 mm	455
PR02 FeCu 0.8 mm	496
PR03 Cu 0.8 mm	1192
PR03 FeCu 0.6 mm	1079
PR03 FeCu 0.8 mm	1185

**MARKING**

The nominal resistance and tolerance are marked on the resistor using four or five colored bands in accordance with IEC 60062, marking codes for resistors and capacitors.

**OUTLINES**

The length of the body ( $L_1$ ) is measured by inserting the leads into holes of two identical gauge plates and moving these plates parallel to each other until the resistor body is clamped without deformation (IEC 60294).

**FUNCTIONAL DESCRIPTION**

**PRODUCT CHARACTERIZATION**

Standard values of nominal resistance are taken from the E96/E24 series for resistors with a tolerance of  $\pm 1\%$  or  $\pm 5\%$ . The values of the E96/E24 series are in accordance with IEC 60063.

**FUNCTIONAL PERFORMANCE**

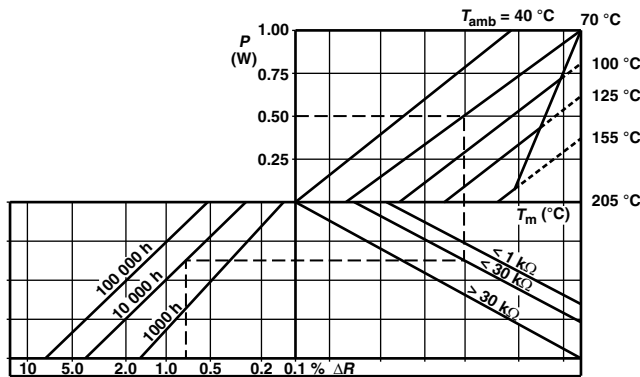

**MOUNTING**

The resistors are suitable for processing on automatic insertion equipment and cutting and bending machines.

MOUNTING PITCH			
TYPE	LEAD STYLE	PITCH	
		mm	e
PR01	Straight leads	12.5 <sup>(1)</sup>	5 <sup>(1)</sup>
	Radial taped	4.8	2
	Double kink large pitch	17.8	7
	Double kink small pitch	12.5	5
PR02	Straight leads	15.0 <sup>(1)</sup>	6 <sup>(1)</sup>
	Radial taped	4.8	2
	Double kink large pitch	17.8	7
	Double kink small pitch	15.0	6
PR03	Straight leads	23.0 <sup>(1)</sup>	9 <sup>(1)</sup>
	Double kink large pitch	25.4	10
	Double kink small pitch	20.0	8

**Note**

<sup>(1)</sup> Recommended minimum value.

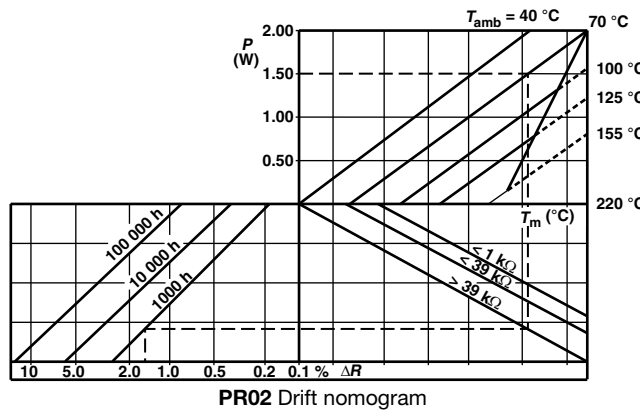
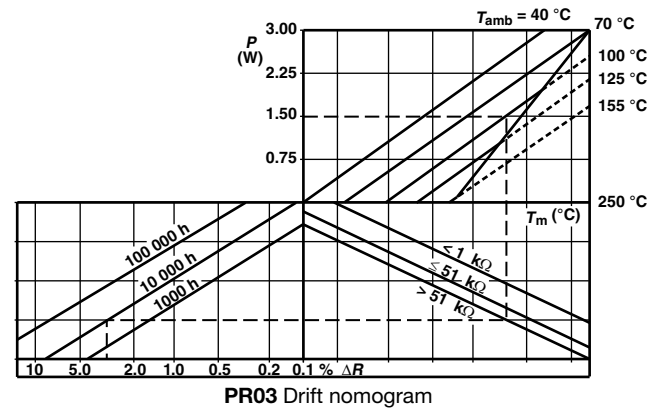

**Note**

- The maximum permissible hot-spot temperature is 205 °C for PR01, 220 °C for PR02 and 250 °C for PR03.

**DERATING**

The power that the resistor can dissipate depends on the operating temperature.

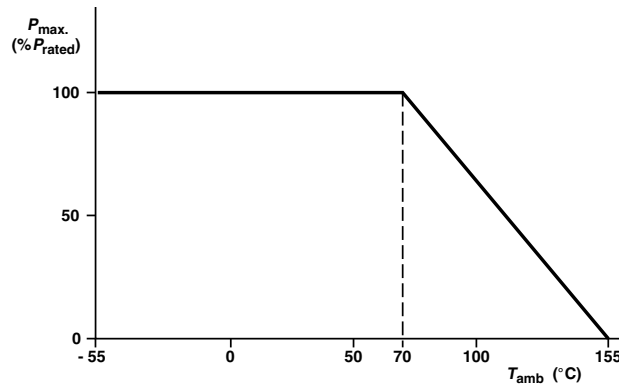

Maximum dissipation ( $P_{max}$ ) in percentage of rated power as a function of the ambient temperature ( $T_{amb}$ )

**PULSE LOADING CAPABILITIES**

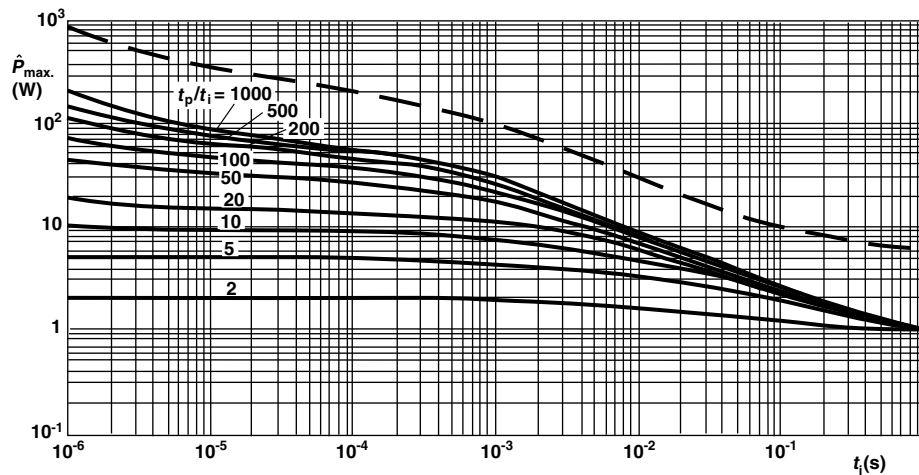

PR01 Pulse on a regular basis; maximum permissible peak pulse power ( $\hat{P}_{max}$ ) as a function of pulse duration ( $t_i$ )

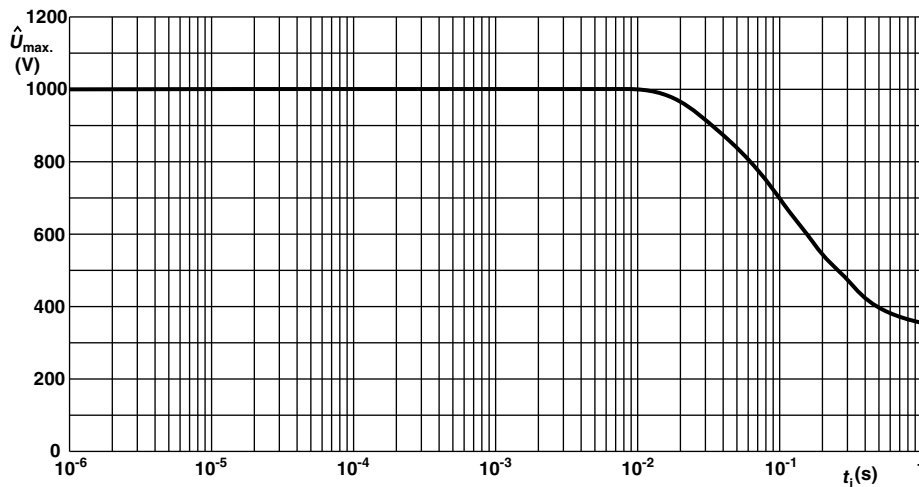

PR01 Pulse on a regular basis; maximum permissible peak pulse voltage ( $\hat{U}_{max}$ ) as a function of pulse duration ( $t_i$ )



PULSE LOADING CAPABILITIES

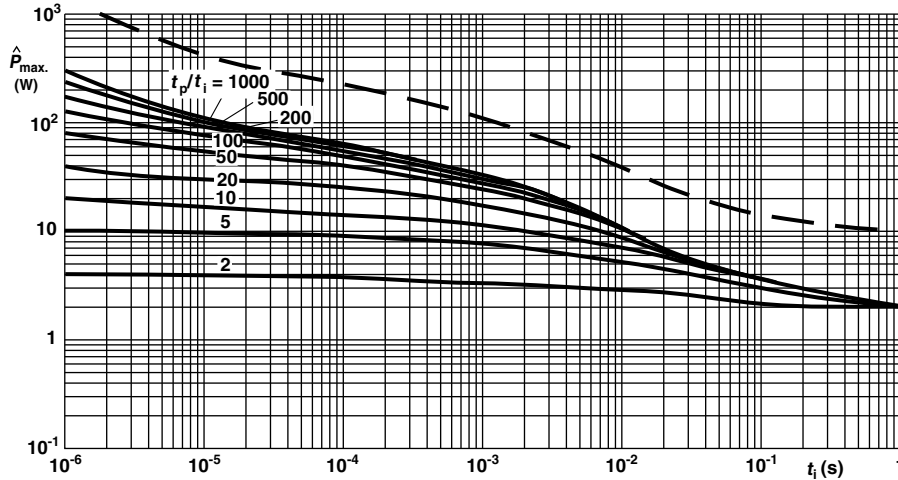

PR02 Pulse on a regular basis; maximum permissible peak pulse power ( $\hat{P}_{max}$ ) as a function of pulse duration ( $t_i$ )

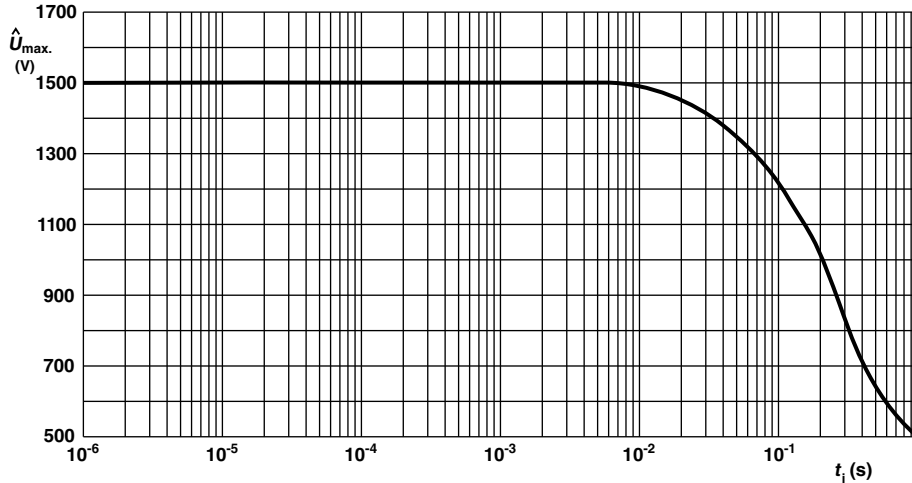

PR02 Pulse on a regular basis; maximum permissible peak pulse voltage ( $\hat{U}_{max}$ ) as a function of pulse duration ( $t_i$ )

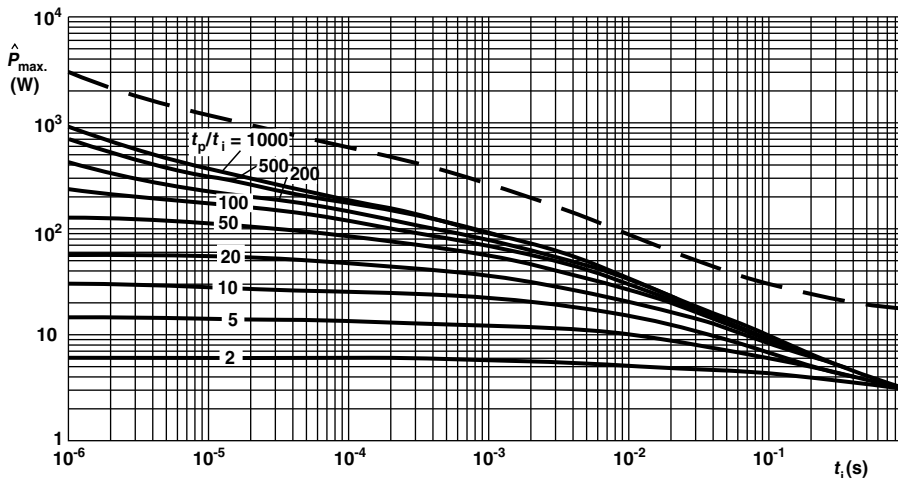

PR03 Pulse on a regular basis; maximum permissible peak pulse power ( $\hat{P}_{max}$ ) as a function of pulse duration ( $t_i$ )

**PULSE LOADING CAPABILITIES**

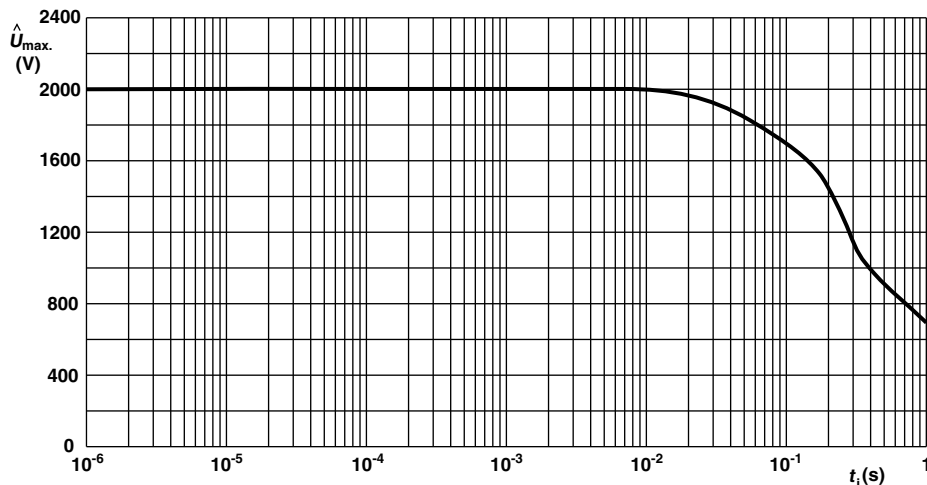

PR03 Pulse on a regular basis; maximum permissible peak pulse voltage ( $\hat{U}_{max}$ ) as a function of pulse duration ( $t_i$ )

**INTERRUPTION CHARACTERISTICS**

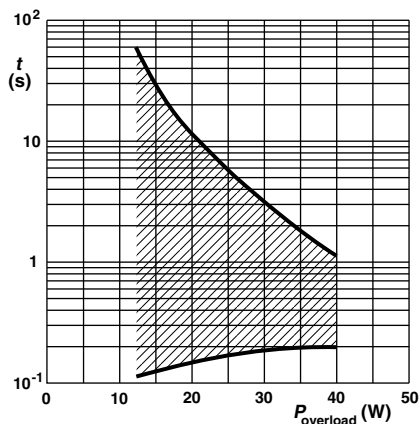

PR01 Time to interruption as a function of overload power for range:  $0 R \leq R_v < 1 R$

This graph is based on measured data under constant voltage conditions; the data may deviate according to the applications.

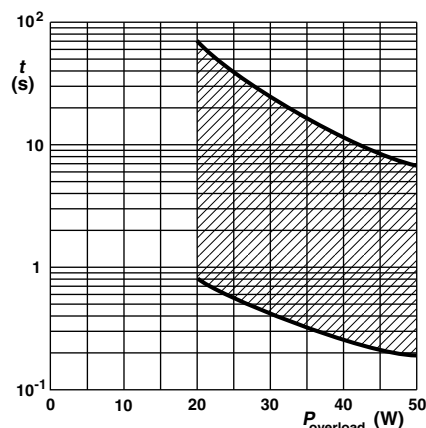

PR01 Time to interruption as a function of overload power for range:  $16 R \leq R_n \leq 560 R$

This graph is based on measured data under constant voltage conditions; the data may deviate according to the applications.

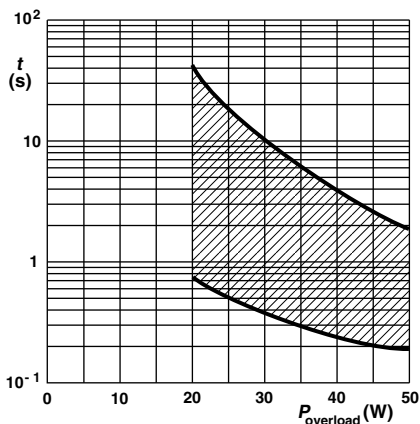

PR01 Time to interruption as a function of overload power for range:  $1 R \leq R_n \leq 15 R$

This graph is based on measured data under constant voltage conditions; the data may deviate according to the applications.

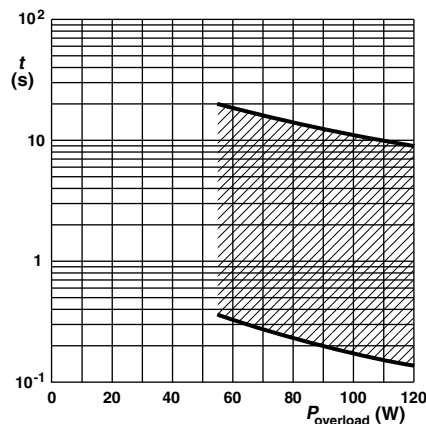

PR02 Time to interruption as a function of overload power for range:  $0.33 R \leq R_n \leq 5 R$

This graph is based on measured data under constant voltage conditions; the data may deviate according to the applications.



**INTERRUPTION CHARACTERISTICS**

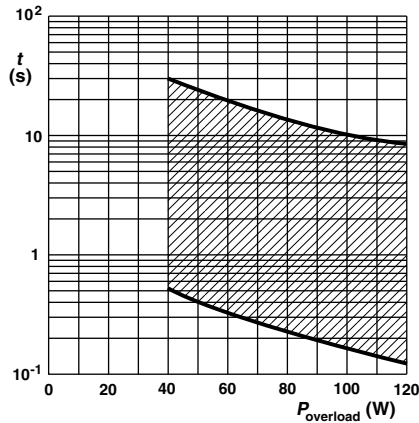

**PR02** Time to interruption as a function of overload power for range:  $5 R \leq R_n \leq 68 R$

This graph is based on measured data under constant voltage conditions; the data may deviate according to the applications.

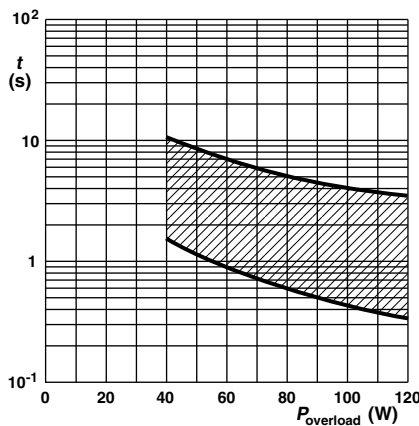

**PR02** Time to interruption as a function of overload power for range:  $68 R \leq R_n \leq 560 R$

This graph is based on measured data under constant voltage conditions; the data may deviate according to the applications.

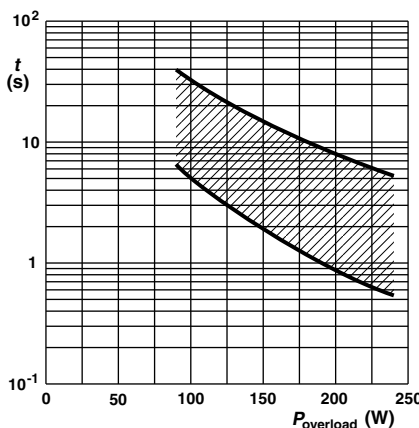

**PR03** Time to interruption as a function of overload power for range:  $0.68 R \leq R_n \leq 560 R$

This graph is based on measured data under constant voltage conditions; the data may deviate according to the applications.

**APPLICATION INFORMATION**

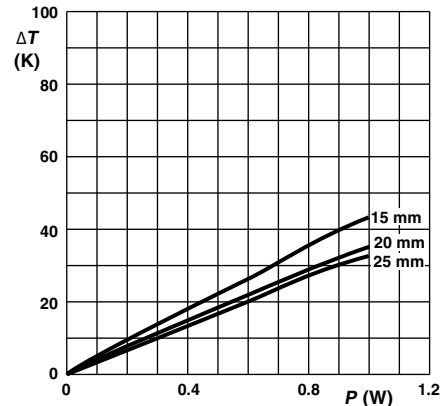

Ø 0.6 mm Cu-leads

Minimum distance from resistor body to PCB = 1 mm

**PR01** Temperature rise ( $\Delta T$ ) at the lead end (soldering point) as a function of dissipated power at various lead lengths after mounting.

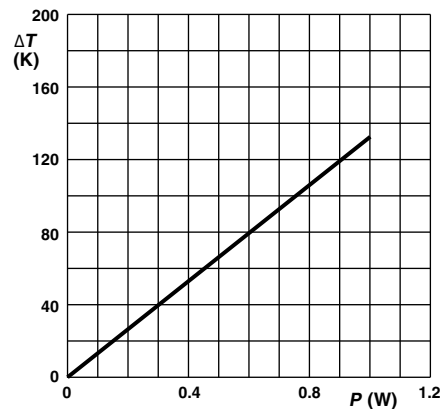

Ø 0.6 mm Cu-leads

**PR01** Hot-spot temperature rise ( $\Delta T$ ) as a function of dissipated power.

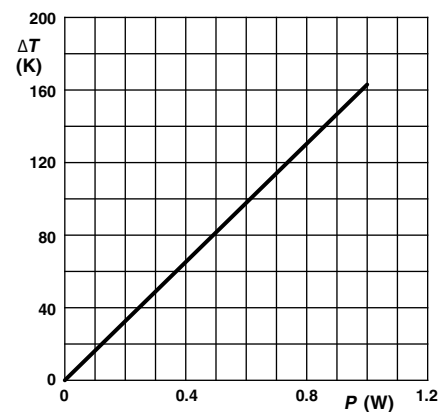

Ø 0.6 mm FeCu-leads

**PR01** Hot-spot temperature rise ( $\Delta T$ ) as a function of dissipated power.

**APPLICATION INFORMATION**

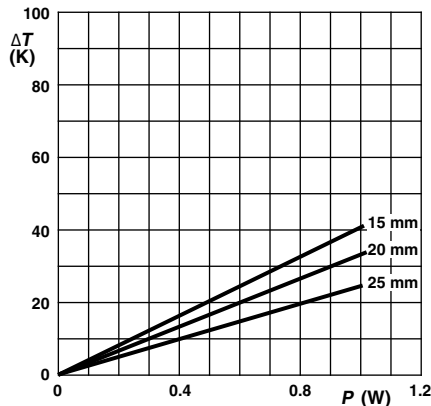

Ø 0.6 mm FeCu-leads  
Minimum distance from resistor body to PCB = 1 mm

**PR01** Temperature rise ( $\Delta T$ ) at the lead end (soldering point) as a function of dissipated power at various lead lengths after mounting.

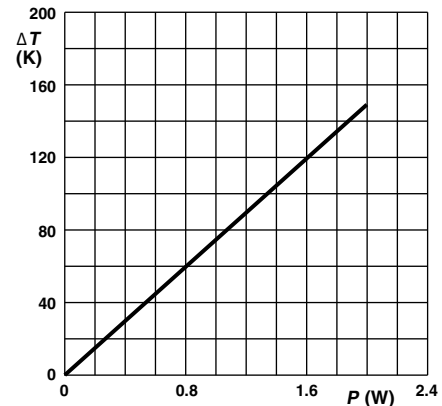

Ø 0.8 mm Cu-leads

**PR02** Hot-spot temperature rise ( $\Delta T$ ) as a function of dissipated power.

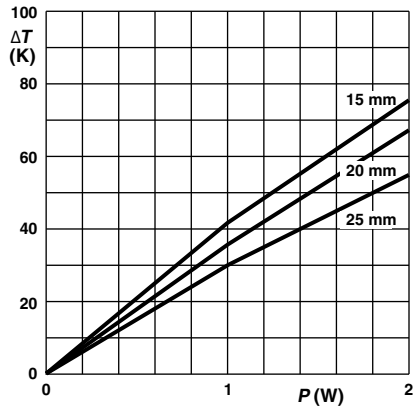

Ø 0.8 mm Cu-leads  
Minimum distance from resistor body to PCB = 1 mm

**PR02** Temperature rise ( $\Delta T$ ) at the lead end (soldering point) as a function of dissipated power at various lead lengths after mounting.

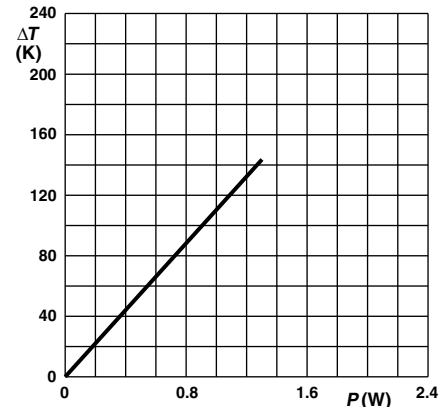

Ø 0.6 mm FeCu-leads

**PR02** Hot-spot temperature rise ( $\Delta T$ ) as a function of dissipated power.

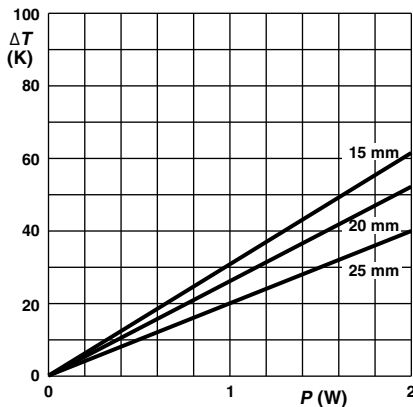

Ø 0.6 mm FeCu-leads  
Minimum distance from resistor body to PCB = 1 mm

**PR02** Temperature rise ( $\Delta T$ ) at the lead end (soldering point) as a function of dissipated power at various lead lengths after mounting.

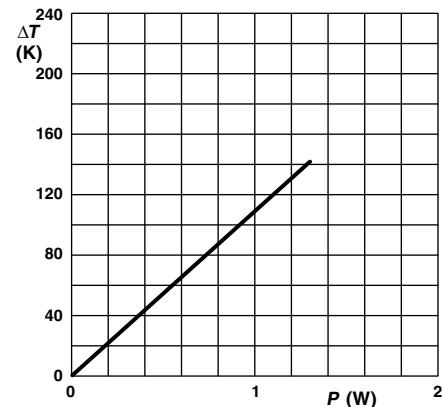

Ø 0.8 mm FeCu-leads

**PR02** Hot-spot temperature rise ( $\Delta T$ ) as a function of dissipated power.



APPLICATION INFORMATION

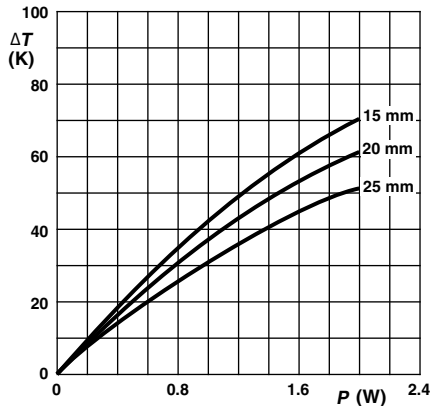

Ø 0.8 mm FeCu-leads  
Minimum distance from resistor body to PCB = 1 mm

**PR02** Temperature rise ( $\Delta T$ ) at the lead end (soldering point) as a function of dissipated power at various lead lengths after mounting.

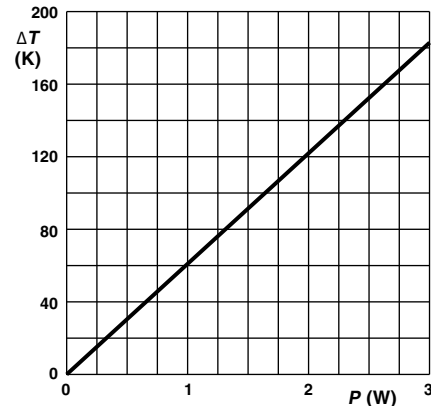

Ø 0.8 mm Cu-leads

**PR03** Hot-spot temperature rise ( $\Delta T$ ) as a function of dissipated power.

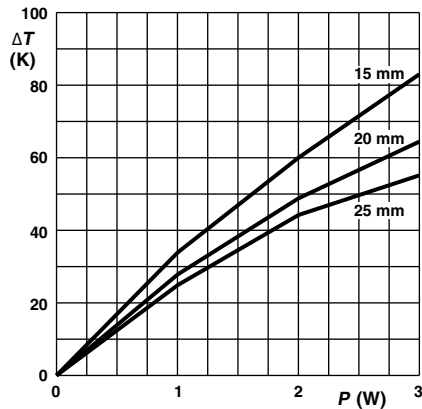

Ø 0.8 mm Cu-leads  
Minimum distance from resistor body to PCB = 1 mm

**PR03** Temperature rise ( $\Delta T$ ) at the lead end (soldering point) as a function of dissipated power at various lead lengths after mounting.

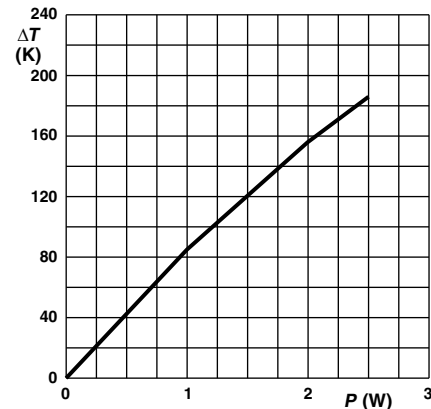

Ø 0.6 mm FeCu-leads

**PR03** Hot-spot temperature rise ( $\Delta T$ ) as a function of dissipated power.

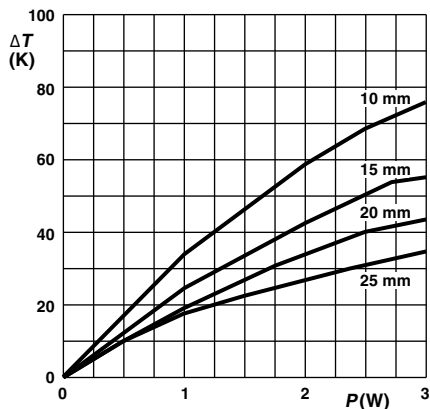

Ø 0.6 mm FeCu-leads  
Minimum distance from resistor body to PCB = 1 mm

**PR03** Temperature rise ( $\Delta T$ ) at the lead end (soldering point) as a function of dissipated power at various lead lengths after mounting.

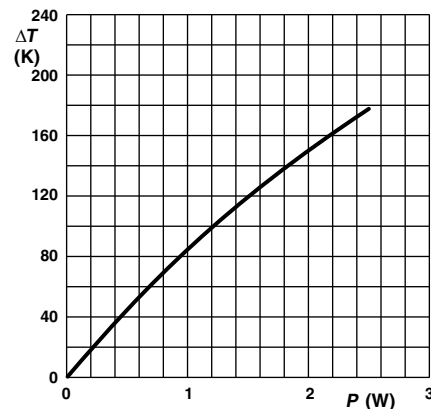

Ø 0.8 mm FeCu-leads

**PR03** Hot-spot temperature rise ( $\Delta T$ ) as a function of dissipated power.

**APPLICATION INFORMATION**

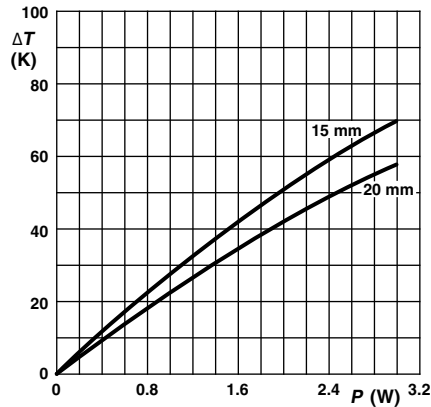

Ø 0.8 mm FeCu-leads  
Minimum distance from resistor body to PCB = 1 mm

**PR03** Temperature rise ( $\Delta T$ ) at the lead end (soldering point) as a function of dissipated power at various lead lengths after mounting.

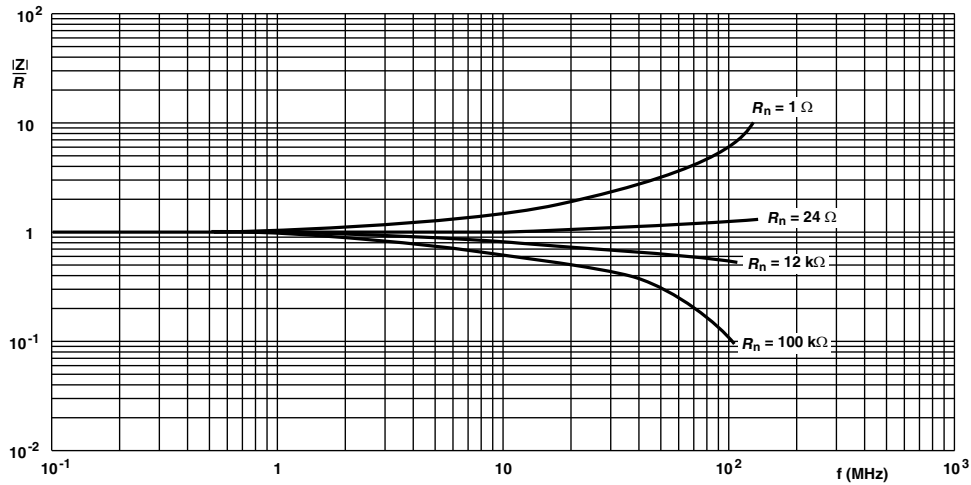

**PR01** Impedance as a function of applied frequency

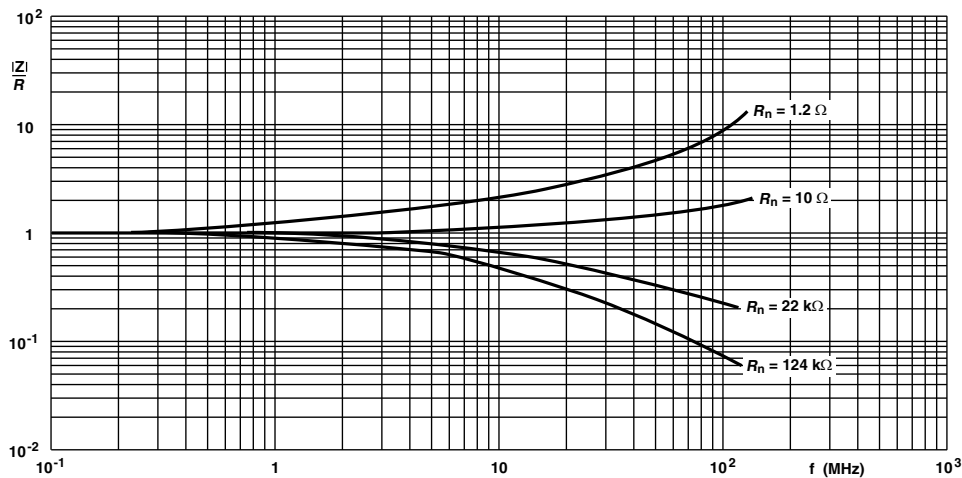

**PR02** Impedance as a function of applied frequency

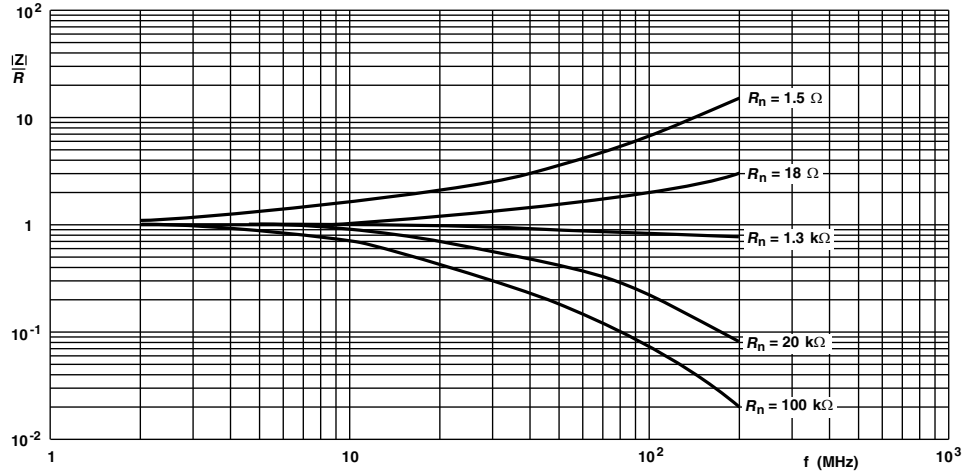
**APPLICATION INFORMATION**

**PR03** Impedance as a function of applied frequency

**TESTS AND REQUIREMENTS**

Essentially all tests are carried out in accordance with IEC 60115-1 specification, category LCT/UCT/56 (rated temperature range: Lower Category Temperature, Upper Category Temperature; damp heat, long term, 56 days).

The tests are carried out in accordance with IEC 60068-2-xx Test Method under standard atmospheric conditions according to IEC 60068-1, 5.3.

In the Test Procedures and Requirements table, tests and requirements are listed with reference to the relevant clauses of IEC 60115-1 and IEC 60068-2-xx test methods. A short description of the test procedure is also given. In some instances deviations from the IEC recommendations were necessary for our method of specifying.

All soldering tests are performed with mildly activated flux.

<b>TEST PROCEDURES AND REQUIREMENTS</b>				
<b>IEC 60115-1 CLAUSE</b>	<b>IEC 60068-2- TEST METHOD</b>	<b>TEST</b>	<b>PROCEDURE</b>	<b>REQUIREMENTS</b>
4.4.1		Visual examination		No holes; clean surface; no damage
4.4.2		Dimensions (outline)	Gauge (mm)	See Straight and Kinked Dimensions tables
4.5		Resistance (refer note on first page for measuring distance)	Applied voltage (+ 0 %/- 10 %): $R < 10 \Omega$ : 0.1 V $10 \Omega \leq R < 100 \Omega$ : 0.3 V $100 \Omega \leq R < 1 \text{ k}\Omega$ : 1 V $1 \text{ k}\Omega \leq R < 10 \text{ k}\Omega$ : 3 V $10 \text{ k}\Omega \leq R < 100 \text{ k}\Omega$ : 10 V $100 \text{ k}\Omega \leq R < 1 \text{ M}\Omega$ : 25 V $R = 1 \text{ M}\Omega$ : 50 V	$R - R_{\text{nom}}$ : max. $\pm 5 \%$
4.18	20 (Tb)	Resistance to soldering heat	Thermal shock: 10 s; 260 °C; 3 mm from body	$\Delta R_{\text{max}}$ : $\pm (1 \% R + 0.05 \Omega)$
4.29	45 (Xa)	Component solvent resistance	Isopropyl alcohol or H <sub>2</sub> O followed by brushing	No visual damage
4.17	20 (Ta)	Solderability	2 s; 235 °C; Solder bath method; SnPb40 3 s; 245 °C; Solder bath method; SnAg3Cu0.5	Good tinning ( $\geq 95 \%$ covered); no damage
		Solderability (after ageing)	8 h steam or 16 h 155 °C; leads immersed 6 mm: for 2 s at 235 °C; solder bath (SnPb40) for 3 s at 245 °C; solder bath (SnAg3Cu0.5)	Good tinning ( $\geq 95 \%$ covered); no damage



TEST PROCEDURES AND REQUIREMENTS				
IEC 60115-1 CLAUSE	IEC 60068-2- TEST METHOD	TEST	PROCEDURE	REQUIREMENTS
4.7		Voltage proof on insulation	Maximum voltage $U_{RMS} = 500$ V during 1 min; metal block method	No breakdown or flashover
4.16		Robustness of terminations:		
4.16.2	21 (Ua1)	Tensile all samples	Load 10 N; 10 s	Number of failures: $< 1 \times 10^{-6}$
4.16.3	21 (Ub)	Bending half number of samples	Load 5 N; 4 x 90°	Number of failures: $< 1 \times 10^{-6}$
4.16.4	21 (Uc)	Torsion other half of samples	3 x 360° in opposite directions	No damage $\Delta R_{max.}: \pm (0.5 \% R + 0.05 \Omega)$
4.20	29 (Eb)	Bump	3 x 1500 bumps in three directions; 40 g	No damage $\Delta R_{max.}: \pm (0.5 \% R + 0.05 \Omega)$
4.22	6 (Fc)	Vibration	Frequency 10 Hz to 500 Hz; displacement 1.5 mm or acceleration 10 g; three directions; total 6 h (3 x 2 h)	No damage $\Delta R_{max.}: \pm (0.5 \% R + 0.05 \Omega)$
4.19	14 (Na)	Rapid change of temperature	30 min at LCT and 30 min at UCT; 5 cycles	No visual damage <b>PR01:</b> $\Delta R_{max.}: \pm (1 \% R + 0.05 \Omega)$ <b>PR02:</b> $\Delta R_{max.}: \pm (1 \% R + 0.05 \Omega)$ <b>PR03:</b> $\Delta R_{max.}: \pm (2 \% R + 0.05 \Omega)$
4.23		Climatic sequence:		
4.23.2	2 (Ba)	Dry heat	16 h; 155 °C	
4.23.3	30 (Db)	Damp heat (accelerated) 1 <sup>st</sup> cycle	24 h; 55 °C; 90 % to 100 % RH	
4.23.4	1 (Aa)	Cold	2 h; - 55 °C	
4.23.5	13 (M)	Low air pressure	2 h; 8.5 kPa; 15 °C to 35 °C	
4.23.6	30 (Db)	Damp heat (accelerated) remaining cycles	5 days; 55 °C; 95 % to 100 % RH	$R_{ins \ min.}: 10^3 \ M\Omega$ $\Delta R_{max.}: \pm (1.5 \% R + 0.1 \Omega)$
4.24	78 (Cab)	Damp heat (steady state)	56 days; 40 °C; 90 % to 95 % RH; loaded with 0.01 $P_{70}$ (Steps: 0 V to 100 V)	$R_{ins \ min.}: 1000 \ M\Omega$ $\Delta R_{max.}: \pm (3 \% R + 0.1 \Omega)$
4.25.1		Endurance (at 70 °C)	1000 h; loaded with $P_{70}$ or $U_{max.}$ ; 1.5 h ON and 0.5 h OFF	$\Delta R_{max.}: \pm (5 \% R + 0.1 \Omega)$
4.8		Temperature coefficient	Between - 55 °C and + 155 °C	$\leq \pm 250 \text{ ppm/K}$
4.6.1.1		Insulation resistance	Maximum voltage (DC) after 1 min; metal block method	$R_{ins \ min.}: 10^4 \ M\Omega$



**12NC INFORMATION FOR HISTORICAL CODING REFERENCE**

The resistors have a 12-digit numeric code starting with 23

For 5 % tolerance:

- The next 7 digits indicate the resistor type and packing
- The remaining 3 digits indicate the resistance value:
  - The first 2 digits indicate the resistance value
  - The last digit indicates the resistance decade

For 1 % tolerance:

- The next 6 digits indicate the resistor type and packing
- The remaining 4 digits indicate the resistance value:
  - The first 3 digits indicate the resistance value
  - The last digit indicates the resistance decade

**Last Digit of 12NC Indicating Resistance Decade**

RESISTANCE DECADE	LAST DIGIT
0.22 Ω to 0.91 Ω	7
1 Ω to 9.76 Ω	8
10 Ω to 97.6 Ω	9
100 Ω to 976 Ω	1
1 Ω to 9.76 kΩ	2
10 Ω to 97.6 kΩ	3
100 Ω to 976 kΩ	4
1 MΩ	5

**12NC Example**

The 12NC for resistor type PR02 with Cu leads and a value of 750 Ω with 5 % tolerance, supplied on a bandolier of 1000 units in ammopack, is: 2306 198 53751.

<b>12NC - Resistor Type and Packaging <sup>(1)</sup></b>									
TYPE	LEAD Ø mm	TOL. (%)	23.. ... .. (BANDOLIER)						
			AMMOPACK				REEL		
			RADIAL TAPED		STRAIGHT LEADS			RADIAL TAPED	
			4000 UNITS	3000 UNITS	52 mm	52 mm	63 mm		52 mm
5000 UNITS	1000 UNITS	500 UNITS	500 UNITS	2000 UNITS					
PR01	Cu 0.6	1	-	-	<b>22 196 1...</b>	06 191 2...	-	06 191 5...	-
		5	06 197 03...	-	<b>22 193 14...</b>	06 197 53...	-	<b>06 197 23...</b>	-
PR02	Cu 0.8	1	-	22 197 2...	-	<b>22 197 1...</b>	-	06 192 5...	<b>2322 197 5...</b>
		5	-	06 198 03...	-	<b>06 198 53...</b>	-	<b>06 198 23...</b>	<b>2322 198 04...</b>
	FeCu 0.6	5	-	-	-	22 194 54...	-	-	-
PR03	Cu 0.8	5	-	-	-	-	<b>22 195 14...</b>	-	-
		1	-	-	-	-	<b>06 199 6...</b>	-	-
	FeCu 0.6	5	-	-	-	-	<b>22 195 54...</b>	-	-

**Notes**

- Preferred types in bold.
- (1) Other packaging versions are available on request.

<b>12NC - Resistor Type and Packaging</b>								
TYPE	LEAD Ø mm	TOL. (%)	23.. ... .. (LOOSE IN BOX)					
			DOUBLE KINK					
			PITCH = 17.8 mm		PITCH = 25.4 mm		PITCH <sup>(2)(3)(4)</sup>	
			1000 UNITS		500 UNITS		500 UNITS	
PR01	Cu 0.6	5	22 193 03...	-	-	-		
	FeCu 0.6	5	22 193 43...	-	<b>22 193 53...</b> <sup>(2)</sup>	-		
PR02	Cu 0.8	5	22 194 23...	-	-	-		
	FeCu 0.6	5	22 194 83...	-	-	-		
	FeCu 0.8	5	-	-	<b>22 194 63...</b> <sup>(3)</sup>	-		
PR03	Cu 0.8	5	-	22 195 23...	-	-		
	FeCu 0.6	5	-	22 195 83...	-	-		
	FeCu 0.8	5	-	-	-	<b>22 195 63...</b> <sup>(4)</sup>		

**Notes**

- Preferred types in bold.
- (2) PR01 pitch 12.5 mm.
- (3) PR02 pitch 15.0 mm.
- (4) PR03 pitch 20.0 mm, with reversed kinking direction as opposed to the drawing for the type with double kink figure.



## Disclaimer

ALL PRODUCT, PRODUCT SPECIFICATIONS AND DATA ARE SUBJECT TO CHANGE WITHOUT NOTICE TO IMPROVE RELIABILITY, FUNCTION OR DESIGN OR OTHERWISE.

Vishay Intertechnology, Inc., its affiliates, agents, and employees, and all persons acting on its or their behalf (collectively, "Vishay"), disclaim any and all liability for any errors, inaccuracies or incompleteness contained in any datasheet or in any other disclosure relating to any product.

Vishay makes no warranty, representation or guarantee regarding the suitability of the products for any particular purpose or the continuing production of any product. To the maximum extent permitted by applicable law, Vishay disclaims (i) any and all liability arising out of the application or use of any product, (ii) any and all liability, including without limitation special, consequential or incidental damages, and (iii) any and all implied warranties, including warranties of fitness for particular purpose, non-infringement and merchantability.

Statements regarding the suitability of products for certain types of applications are based on Vishay's knowledge of typical requirements that are often placed on Vishay products in generic applications. Such statements are not binding statements about the suitability of products for a particular application. It is the customer's responsibility to validate that a particular product with the properties described in the product specification is suitable for use in a particular application. Parameters provided in datasheets and/or specifications may vary in different applications and performance may vary over time. All operating parameters, including typical parameters, must be validated for each customer application by the customer's technical experts. Product specifications do not expand or otherwise modify Vishay's terms and conditions of purchase, including but not limited to the warranty expressed therein.

Except as expressly indicated in writing, Vishay products are not designed for use in medical, life-saving, or life-sustaining applications or for any other application in which the failure of the Vishay product could result in personal injury or death. Customers using or selling Vishay products not expressly indicated for use in such applications do so at their own risk. Please contact authorized Vishay personnel to obtain written terms and conditions regarding products designed for such applications.

No license, express or implied, by estoppel or otherwise, to any intellectual property rights is granted by this document or by any conduct of Vishay. Product names and markings noted herein may be trademarks of their respective owners.

## Material Category Policy

**Vishay Intertechnology, Inc. hereby certifies that all its products that are identified as RoHS-Compliant fulfill the definitions and restrictions defined under Directive 2011/65/EU of The European Parliament and of the Council of June 8, 2011 on the restriction of the use of certain hazardous substances in electrical and electronic equipment (EEE) - recast, unless otherwise specified as non-compliant.**

**Please note that some Vishay documentation may still make reference to RoHS Directive 2002/95/EC. We confirm that all the products identified as being compliant to Directive 2002/95/EC conform to Directive 2011/65/EU.**

**Vishay Intertechnology, Inc. hereby certifies that all its products that are identified as Halogen-Free follow Halogen-Free requirements as per JEDEC JS709A standards. Please note that some Vishay documentation may still make reference to the IEC 61249-2-21 definition. We confirm that all the products identified as being compliant to IEC 61249-2-21 conform to JEDEC JS709A standards.**



# Mouser Electronics

Authorized Distributor

Click to View Pricing, Inventory, Delivery & Lifecycle Information:

## Vishay:

[PR01000101208JR500](#) [PR01000101500JR500](#) [PR01000101501JR500](#) [PR01000101509JR500](#)  
[PR01000102702JR500](#) [PR01000103908JR500](#) [PR01000105100JR500](#) [PR01000106800JR500](#)  
[PR01000108200JR500](#) [PR02000201008JR500](#) [PR02000201509JR500](#) [PR02000202208JR500](#)  
[PR02000202703JR500](#) [PR02000203300JR500](#) [PR02000204703JR500](#) [PR02000206800JR500](#)  
[PR03000206802JAC00](#) [PR01000104709JR500](#) [PR01000107502JR500](#) [PR02000204701JR500](#)  
[PR03000208209JAC00](#) [PR03000202402JAC00](#) [PR03000201001JAC00](#) [PR03000206201JAC00](#)  
[PR01000104301JR500](#) [PR03000202009JAC00](#) [PR01000105109JR500](#) [PR01000101003JR500](#)  
[PR03000205101JAC00](#) [PR02000205601JR500](#) [PR01000102009JR500](#) [PR01000103000JR500](#)  
[PR03000202001JAC00](#) [PR02000201503JR500](#) [PR02000205109JR500](#) [PR01000102209JR500](#)  
[PR02000203302JR500](#) [PR02000204708JR500](#) [PR01000101508JA100](#) [PR01000101108JA100](#)  
[PR03000201202JAC00](#) [PR03000202008JAC00](#) [PR03000201008JAC00](#) [PR03000202709JAC00](#)  
[PR03000204708JAC00](#) [PR03000204308JAC00](#) [PR03000203008JAC00](#) [PR03000203308JAC00](#)  
[PR03000201308JAC00](#) [PR03000201608JAC00](#) [PR03000201108JAC00](#) [PR03000203908JAC00](#)  
[PR03000203608JAC00](#) [PR03000202408JAC00](#) [PR03000209108JAC00](#) [PR03000207508JAC00](#)  
[PR03000206808JAC00](#) [PR03000201808JAC00](#) [PR03000201208JAC00](#) [PR03000206208JAC00](#)  
[PR03000208208JAC00](#) [PR01000101209JR500](#) [PR03000206803JAC00](#) [PR03000207502JAC00](#)  
[PR01000101008JR500](#) [PR01000104708JR500](#) [PR02000202201JR500](#) [PR02000205609JR500](#)  
[PR01000101004JR500](#) [PR03000205108JAC00](#) [PR01000104700JR500](#) [PR03000206200JAC00](#)  
[PR02000201002JR500](#) [PR01000104702JR500](#) [PR01000105102JR500](#) [PR01000106209JR500](#)  
[PR02000201009JR500](#) [PR02000202002JR500](#) [PR03000209109JAC00](#) [PR01000101302JR500](#)  
[PR01000101802JR500](#) [PR01000102002JR500](#) [PR01000102708JR500](#) [PR01000103009JR500](#)  
[PR01000103902JR500](#) [PR01000103301JR500](#) [PR01000106808JR500](#) [PR01000107508JR500](#)  
[PR01000108201JR500](#) [PR02000201003JR500](#) [PR02000201101JR500](#) [PR02000202701JR500](#)  
[PR02000203009JR500](#) [PR02000204300JR500](#) [PR02000204309JR500](#) [PR02000205603JR500](#)  
[PR02000206203JR500](#) [PR02000209100JR500](#) [PR02000209108JR500](#) [PR03000201103JAC00](#)